



# UTL8200 Series Electronic Load

## User Manual



## Preface

Thank you for purchasing this brand new product. In order to use this product safely and correctly, please read this manual thoroughly, especially the safety notes.

After reading this manual, it is recommended to keep the manual at an easily accessible place preferably close to the device, for future reference.

## Copyright Information

Uni-Trend Technology (China) Co., Ltd. all rights reserved.

UNI-T is the registered trademark of Uni-Trend Technology (China) Co., Ltd.

UNI-T products are protected by patent rights in China and other countries, including issued and pending patents. Uni-Trend reserves the rights to any product specification and pricing changes.

Uni-Trend reserves all rights. Information in this manual supersedes all previously published versions. No part of this manual may be copied, extracted or translated by any means without the prior permission of Uni-Trend.

## Warranty Service

The instrument has a warranty period of one year from the date of purchase. If the instrument is damaged due to improper operation by the user during the warranty period, the maintenance fee and the costs caused by the maintenance shall be borne by the user, and the instrument shall be maintained by the company for life.

If the original purchaser sells or transfers the product to a third party within one year from the date of purchase of the product, the warranty period of one year shall be from the date of the original purchase from UNI-T or an authorized UNI-T distributor. Power cords, accessories and fuses, etc. are not included in this warranty.

If the product is proved to be defective within the warranty period, UNI-T reserves the rights to either repair the defective product without charging of parts and labor, or exchange the defected product to a working equivalent product (determined by UNI-T). Replacement parts, modules and products may be brand new, or perform at the same specifications as brand new products. All original parts, modules, or products which were defective become the property of UNI-T.

The "customer" refers to the individual or entity that is declared in the guarantee. In order to obtain the warranty service, "customer" must inform the defects within the applicable warranty period to UNI-T, and perform appropriate arrangements for the warranty service.

The customer shall be responsible for packing and shipping the defective products to the designated maintenance center of UNI-T, pay the shipping cost, and provide a copy of the purchase receipt of the original purchaser. If the product is shipped domestically to the location of the UNI-T service center, UNI-T shall pay the return shipping fee. If the product is sent to any other location, the customer shall be responsible for all shipping, duties, taxes, and any other expenses.

## Guarantee Limit

This warranty shall not apply to any defects, malfunction or damages caused by accidental, machine parts' wear and tear, using outside the product's specifications, improper use, and improper or lacking of maintenance. UNI-T under the provisions of this warranty has no obligation to provide the following services:

- a) Any repair damage caused by the installation, repair, or maintenance of the product by non UNI-T service representatives;
- b) Any damage caused by improper use or connection to an incompatible device;
- c) Any damage or malfunction caused by the use of a power source not provided by UNI-T;
- d) Any maintenance on altered or integrated products (if such alteration or integration leads to an increase in time or difficulty of product maintenance).

This warranty is written by UNI-T for this product and it is used to substitute any other express or implied warranties. UNI-T and its distributors do not offer any implied warranties for merchantability or applicability purposes. For violation of this guarantee, UNI-T is responsible for the repair or replacement of defective products as the only and complete remedy available to customers. Regardless of whether UNI-T and its distributors are informed that any indirect, special, incidental, or consequential damage may occur, the UNI-T and its distributors shall not be responsible for any of these damages.

## Safety Information



**Warning**  **Danger:** To avoid electric shock and personal injury, please follow the following guidelines.

### Disclaimer

Please read the following safety information carefully before using the instrument. UNI-T

will not be liable for the personal injury and property losses caused by the user's failure to comply with the following terms.

**Correct connection of ground wire**

To avoid electric shock, please use the provided cable to connect and make sure that the product is properly grounded before use.

**Operating voltage**

Please ensure that the main supply does not exceed 10% of rated operating range to prevent product damage.

**Use the correct power cord**

Only use the dedicated UNI-T power cord to connect the measured power supply and the electronic load to ensure that there is no overheat by short-circuit current, otherwise electric shock may occur.









**Input voltage**

Please notice the product symbols before connecting. The instrument supports 2 kinds of AC input method: 110V and 220V. Please check if the switch of load matches with the input power source and if the fuse is correctly installed.

**Please do not use the instrument in inflammable and explosive environment.**

Do not use or store the instrument in high temperature, high humidity, flammable, explosive and strong magnetic field environments.

**Safety symbols**

	Danger		Power on
	Grounding		Power off
	Protective grounding		Chassis
	Signal ground		Warning

**Environment-Friendly Use Period (EFUP)**



This product contains certain hazardous substances and can be used safely during its environmental-friendly use period (EFUP) of 40 years, as shown in the symbol on the left. If the specified time is exceeded, the product should be recovered.

**Waste Electrical and Electronic Equipment (WEEE) Instruction 2002/96/EC**



Do not dispose the product and its accessories in trash bin.

## Table of Contents

Preface.....	2
Copyright Information .....	2
Warranty Service .....	2
Guarantee Limit .....	3
Safety Information.....	3
1. Product Overview .....	6
1.1 Product Series .....	6
1.2 Front Panel .....	8
1.3 Rear Panel.....	9
2. Inspection and Installation .....	10
2.1 Packing List .....	10
2.2 Requirements of Power Supply.....	10
2.3 Operating Environment .....	11
2.4 Cleaning.....	11
3. Measurement Display Interface.....	11
3.1 Power on and Run.....	12
3.2 Measurement Interface .....	12
3.2.1 Introduction of Screen Display .....	12
3.2.2 Measurement Interface Display .....	13
3.2.3 Status Information .....	13
3.2.4 Running Indicator .....	13
4. Measurement Settings.....	13
4.1 Mode Setting and Test.....	14
4.1.1 Constant Current Test .....	14
4.1.2 Constant Voltage Test .....	15
4.1.3 Constant Resistance Test .....	16
4.1.4 Constant Power Test .....	16
4.1.5 Dynamic Test.....	17
4.1.6 List Test .....	19
4.1.7 Battery Test .....	20
4.2 Short Circuit Test .....	21
4.3 Parameter Input and Operating Control.....	22
4.4 Alarm Prompts .....	22
4.5 Local/Remote .....	23
5. System Configuration Page (Menu) .....	23
5.1 System Configuration .....	24
5.2 Parameter Setting.....	25
5.3 File .....	26
5.4 Instrument Info.....	26
6. Communication .....	26
6.1 Communication Interfaces.....	26
6.2 Communication Settings .....	27

## 1. Product Overview

- Product Series (Features and Technical Specifications)
- Front Panel
- Rear Panel

### 1.1 Product Series

UTL8200 series DC electronic load contains 2 models: UTL8211 and UTL8212.

Model	Channel quantity	Measurement range		
		Voltage	Current	Power
UTL8211	Single channel	0~150V	0~40A	0~400W
UTL8212	Dual channel	0~150V	0~20A	0~200W

The UTL8200 series electronic load has a 2.8 inch LCD display. It is convenient to operate, stylish in appearance, and supports dual-channel independent testing. The electronic load has a wide power measurement range, the voltage and current measurement speed is up to 40 kHz, the test resolution can reach 1mV/1mA, and it has various test functions and modes for users to choose. The instrument can be configured with RS232 communication module to flexibly meet on-site test conditions, and is convenient to connect with automated production lines and automatic test systems (ATS).

#### 1.1.1 Features

- Four basic test modes: CC/CV/CR/CP
- High resolution of 1mV/1mA
- Minimum rise time of dynamic current test: 500us
- Voltage and current measurement speed up to 40kHz
- Multi-mode battery discharge test
- List mode, support automatic test
- Independent short-circuit test function
- Protections of over-voltage/ under-voltage/ over-current/ over-power/ overheat/ anti-reverse connection
- Support RS232 communication interface
- Configured with upper computer software for remote control and monitoring
- Power-off memory function
- Intelligent temperature-controlled fan
- Chinese/English interface

## 1.1.2 Technical Specifications

Model		UTL8211	UTL8212
Channel quantity		Single channel	Dual channel
Rated value	Voltage	0~150V	0~150V
	Current	0~4A, 0~40A	0~2A, 0~20A
	Power	400W	2×200W
CV mode	Range	0~18V, 0~150V	
	Resolution	1 mV, 10 mV	
	Precision	±(0.05%+0.1% FS)	
CC mode	Range	0~4A, 0~40A	0~2A, 0~20A
	Resolution	1mA, 10mA	
	Precision	± ( 0.05% + 0.05%FS )	
CR mode	Range	0.05Ω~7.5kΩ	
	Resolution	16 bit	
	Precision	0.1% + 0.5%FS	
CP mode	Range	400W	200W
	Resolution	10mW	10mW
	Precision	0.1% + 0.5%FS	
<b>Dynamic current</b>			
Dynamic mode	T1&T2	100μS~3600S	
	Precision	5 μS±100 ppm	
	Slope	0.001~0.15 A/μS	
Voltage readback	Range	0~18V, 0~150V	
	Resolution	1mV, 10mV	
	Precision	± ( 0.05% + 0.1%FS )	
Current readback	Range	0~4A, 0~40A	0~2A, 0~20A
	Resolution	1mA, 10mA	
	Precision	± ( 0.05% + 0.1%FS )	
Power readback	Range	400W	200W
	Resolution	10mW	
	Precision	± ( 0.1% + 0.5%FS )	
<b>Basic protection</b>			
Power protection	≥Set value×1.01, delay protection, max 404W	≥Set value×1.01, delay protection, max 202W	
	≥Set value×1.1, immediate protection, max	≥Set value×1.1, immediate protection, max 220W	
Current protection	≥Set value×1.01, delay protection, max 40.4A	≥Set value×1.01, delay protection, max 20.2A	
	≥Set value×1.1, immediate protection, max 44A	≥Set value×1.1, immediate protection, max 22A	
Voltage protection	≥Set value×1.01, delay protection, max 152V		
	≥Set value×1.1, immediate protection, max 165V		
Temperature protection	≥95°C		
Product size (Width*Height*Depth)	88mm×174mm×300mm		
Product weight	3.6kg (net weight)		

Recommended calibration frequency: once/year

AC power input level: (the switch on the rear panel can choose 110V or 220V)

110V position: 110V±10% 50~60Hz

220V position: 220V±10% 50~60Hz

## 1.2 Front Panel

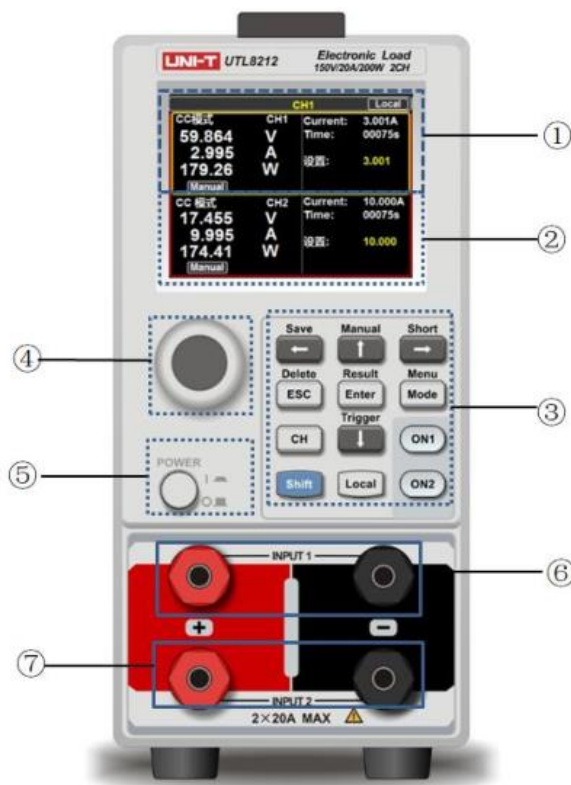

Figure 1-2 UTL8212 Front Panel (Dual Channel)

No.	Item	Description
①	LCD display Channel 1	It is used to display the operating status, measurement parameters and mode of channel 1.
②	LCD display Channel 2	It is used to display the operating status, measurement parameters and mode of channel 2.
③	Buttons	They are used to select test modes (CC, CV, CR, CP and more); In other interfaces, follow the on-screen instructions to perform specific operating functions
④	Pulse knob	It is used to adjust the parameters or move cursor in the menu.
⑤	Power button	Press it to power on/off.
⑥	Channel 1 Input terminals	They are used to connect power supply. Please do not inversely connect to prevent damage.
⑦	Channel 2 Input terminals	They are used to connect power supply. Please do not inversely connect to prevent damage.



### 1.2.1 Buttons

Item	Description
Shift	Press to operate functions printed above buttons
Direction buttons	They are used to move cursor or adjust the selected value.
Enter	It is used to confirm/modify the selected items or parameters.
Local	Remote/Local: it is used to select local or remote control mode.
ESC	Return to the previous menu
Mode	It is used to set the operating mode.
CH	It is used to switch channel (UTL8212 only).
ON1/ON2	Load input control: ON/OFF

### 1.2.2 Shortcuts

The buttons on the panel can be used together with the Shift button to realize the functions marked above the buttons. Press Shift first, and then press other buttons.

Buttons	Description
Shift+← (Save)	Save list files
Shift+↑ (Manual)	Switch trigger mode
Shift+→ (Short)	Short circuit test
Shift+ ESC (Delete)	Delete list files
Shift+ Enter (Result)	View list test results
Shift+ Mode (Menu)	System setting interface
Shift+↓ (Trigger)	Manual trigger

### 1.3 Rear Panel



No.	Item	Description
1	AC220/110V socket	AC power supply input socket (with fuse)
2	AC220/110V transfer switch	Voltage position switch of AC power supply
3	RS232 interface	External communication interface to realize the remote control with the load

## 2. Inspection and Installation

- Packing List
- Requirements of Power Supply
- Operating Environment
- Cleaning

### 2.1 Packing List

**Before using the instrument, please first:**

1. Check whether the product's appearance is damaged, scratched or has other defects;
2. Check whether the accessories are missing according to the packing list.

If it is damaged or the accessories are missing, please contact UNI-T Instrument Sales Department or the distributor immediately.

Items	Quantity	Remarks
DC electronic load	1	The model is subject to the actual order.
Power Cord	1	Use only a specified power cord which is authorized in the country of use.
250VA/0.5A spare fuses	2	Note: 110V input voltage only
User manual	1	Users can download it from UNI-T's official website.

### 2.2 Requirements of Power Supply

UTL8200 series can only be used in following conditions:

Parameters	Requirements
Voltage	AC 220/110 ( $\pm 10\%$ )V
Frequency	50/60Hz
Power	50W
Fuse	AC220V input voltage: 250V/0.25A AC110V input voltage: 250V/0.5A

- Three-core power cable is provided; please make sure that the ground wire of the three-phase socket is properly grounded before use.
- The instrument comes with 220V/110V power transfer switch. Before powering on, please ensure that the switch is in the correct position.
- 250V/0.25A (5x20mm) fuse is selected and installed for the instrument (220V).
- In addition, 2 spare fuses of 250V/0.5A are provided for input voltage of AC 110V.
- When replacing the fuse, please unplug the external power cable first, then open the fuse slot under the power interface, take out the old fuse and replace it with a new one, and install the fuse slot back after completion.



**Warning:** Please do not use the damaged power cable to avoid danger. Use the 250V/0.5A fuse when 110V AC power is input.

## 2.3 Operating Environment

The operating environment requirements are listed as follows. During the on-load process, the speed of the cooling fan will be intelligently adjusted based on the change of the cooling fin's temperature.

Operating environment	Requirements
Operating temperature	0°C~40°C
Operating humidity	20%~80% (Non-condensing)
Storage temperature	-10°C~60°C
Altitude	≤2000m
Degree of pollution	II

## 2.4 Cleaning

To avoid electric shock, please unplug the power cable before cleaning.

Clean the housing and the panel with a soft damp cloth, and make sure it is completely dry.

Do not clean the inside of the instrument.



**Warning:** Do not use solvents such as alcohol and gasoline.

## 3. Measurement Display Interface

- Power on and Run
- Measurement Interface

### 3.1 Power on and Run

The correct power-on and self-inspection processes of the electronic load are as follows:

1. To power the electronic load on, please connect the power cable correctly, and press the power button on the front panel. The electronic load screen will display the progress bar of current power-on and self-inspection.
2. After initialization, the measuring status will be displayed on the screen. If the start-up mode has been set, the instrument will enter the preset measurement mode directly.

The completion of correct power-on and self-check indicates that the load meets the factory standards, so users can use it normally.



**Warning:** Please make sure that the power supply voltage is consistent with the supply voltage before turning on the power, otherwise the instrument will be burnt out. Please be sure to connect the main power plug to a power socket with ground protection. Do not use a wiring board without ground protection.

### 3.2 Measurement Interface

#### 3.2.1 Introduction of Screen Display

After entering the test mode, the LCD screen will be divided into several areas to display different information. Take the UTL8212 dual-channel CC mode display interface as an example, as shown in Figure 3-2-1.

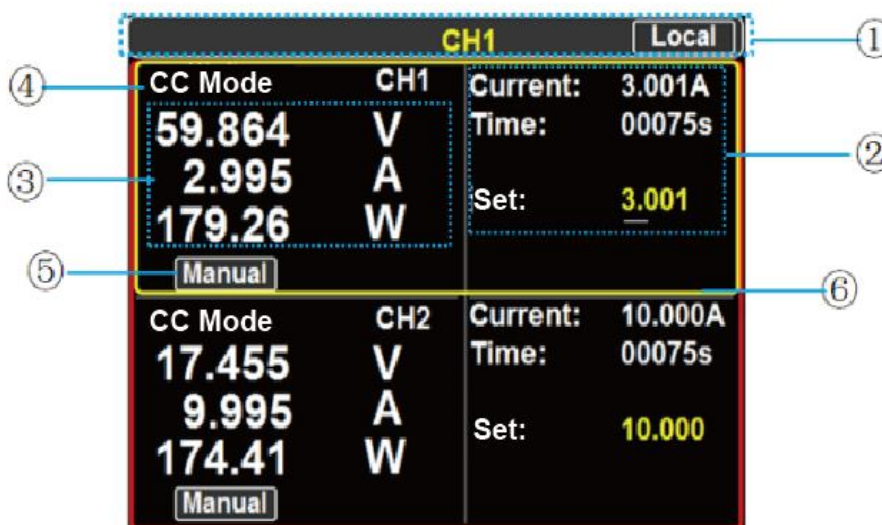

Figure 3-2-1 CC Mode Display Interface (UTL8212)

### 3.2.2 Measurement Interface Display

No.	Items	Description
①	Status information	Current status, channel and local control
②	Set value area	Display mode setting information
③	Operating data	Display real-time voltage, current and power
④	Current mode	Display the mode
⑤	Mode information	Display the status of short circuit test, trigger function, etc.
⑥	Yellow wireframe	Display the selected channel (UTL8212 only)

### 3.2.3 Status Information

Status	Display status	Description
Mode status	CC/CV/CP/CR mode	Current measurement status or operating mode
Control mode	Local/Remote	Current operating mode: Local/Remote
Trigger mode	[Manual]/[Ext Trig]	Current trigger mode: Manual/External
Trigger ready	[Trigger]	Wait for trigger, the icon will disappear after triggering
Short circuit	[Short]	Short circuit test mode

### 3.2.4 Running Indicator

The UTL8200 series electronic load comes with running indicator on the ON button. In on-load mode, the indicator will light up (red), indicating that the load is in a loaded status. Pressing the ON button again can stop loading and the indicator will go out.



**Note:** The yellow frame indicates the position of the cursor (the selected mode).

## 4. Measurement Settings

- Mode Setting and Test (CC/CV/CR/CP/Dynamic/List/Battery)
- Short Circuit Test
- Parameter Input and Operating Control
- Alarm Prompts

- Local/Remote

## 4.1 Mode Setting and Test

The UTL8200 series electronic load has 7 commonly used test modes: CC, CV, CR, CP, Dynamic, List, and Battery. Pressing the Mode button will enter the mode selection interface. In the interface, use the direction buttons or the pulse knob to select a mode, and press Enter to enter the corresponding mode setting interface.

Items	Description
CC mode	The electronic load always consumes constant current regardless of the input voltage.
CV mode	The electronic load changes current consumption to keep the input voltage as the set value.
CR mode	The electronic load is equivalent to a resistance; it changes the input current as the voltage changes.
CP mode	The electronic load always consumes constant power; it reduces the current when the voltage rises to remain constant power.
Dynamic test	Two different current values are set. The load will switch between these two values when testing.
List test	Up to 16-step different loading modes can be set. It can customize the stepping mode and the upper and lower limits of test and judgment, and can save the list test files.
Battery test	Discharge the measured battery by CC/CR/CP mode. The test will end automatically when reaching the ending value. The battery capacity will also be displayed.

### 4.1.1 Constant Current Test

In CC mode, the electronic load always consumes constant current regardless of the input voltage.

In the mode selection interface, select the CC mode, press Enter to enter the main operating interface, and enter the current value in the main interface. Press the ON button, the electronic load starts to load, and the indicator light lights up. If the users need to stop the load, press the ON button again, and the indicator light goes out.

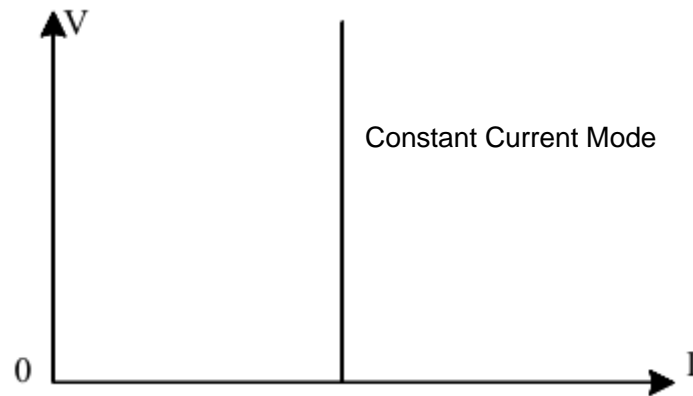

Figure 4-1-1 Relationship of Voltage and Current in CC Mode

**Operation steps:**

1. After starting up, first press the CH button to select the operating channel. The yellow wireframe area is the selected channel. And CH1 or CH2 will be displayed at the top of the screen (UTL8212 only).
2. Press the Mode button to enter the mode selection interface, select the CC mode with the pulse knob or direction buttons, and then press Enter to enter the test interface.
3. Adjust the current setting value (constant current value) with the knob.
4. Press the ON button to start the operation, and press the ON button again to stop it.

#### 4.1.2 Constant Voltage Test

In CV mode, the electronic load changes current consumption to keep the input voltage as set value.

In the mode selection interface, select the CV mode, press Enter to enter the main operating interface, and enter the voltage value in the main interface. Press the ON button, the electronic load starts to load, and the indicator light lights up. If the users need to stop the load, press the ON button again, and the indicator light goes out.

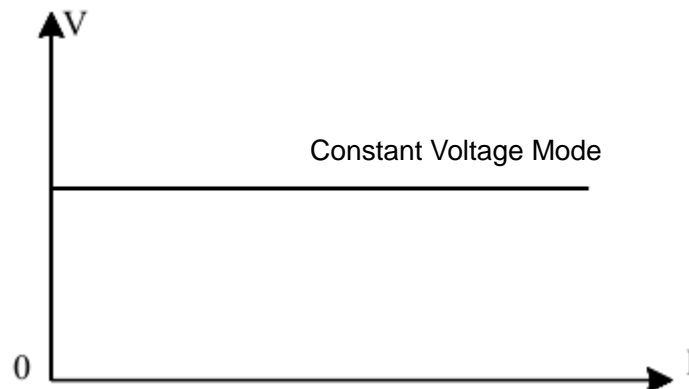

Figure 4-1-2 Relationship of Voltage and Current in CV Mode

**Operation steps:**

1. After starting up, first press the CH button to select the operating channel. The yellow wireframe area is the selected channel. And CH1 or CH2 will be displayed at the top

- of the screen (UTL8212 only).
2. Press the Mode button to enter the mode selection interface, select the CV mode with the pulse knob or direction buttons, and then press Enter to enter the test interface.
  3. Adjust the voltage setting value (constant voltage value) with the knob.
  4. Press the ON button to start the operation, and press the ON button again to stop it.

### 4.1.3 Constant Resistance Test

In CR mode, the electronic load is equivalent to a resistance; it changes the input current as the voltage changes to maintain a constant resistance value.

In the mode selection interface, select the CR mode, press Enter to enter the main operating interface, and enter the resistance value in the main interface. Press the ON button, the electronic load starts to load, and the indicator light lights up. If the users need to stop the load, press the ON button again, and the indicator light goes out.

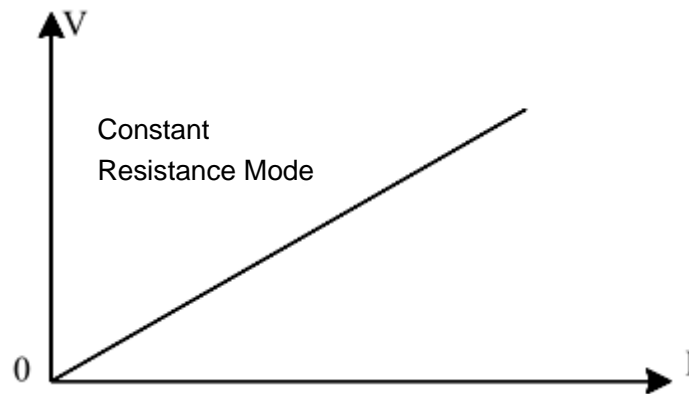

Figure 4-1-3 Relationship of Voltage and Current in CR Mode

#### Operation steps:

1. After starting up, first press the CH button to select the operating channel. The yellow wireframe area is the selected channel. And CH1 or CH2 will be displayed at the top of the screen (UTL8212 only).
2. Press the Mode button to enter the mode selection interface, select the CR mode with the pulse knob or direction buttons, and then press Enter to enter the test interface.
3. Adjust the resistance setting value (constant resistance value) with the knob.
4. Press the ON button to start the operation, and press the ON button again to stop it.

### 4.1.4 Constant Power Test

In CP mode, the electronic load consumes constant power, and it will adjust the current according to the voltage change to maintain the set power value.

In the mode selection interface, select the CP mode, press Enter to enter the main operating interface, and enter the power value in the main interface. Press the ON button, the electronic load starts to load, and the indicator light lights up. If the users need to stop the load, press the ON button again, and the indicator light goes out.



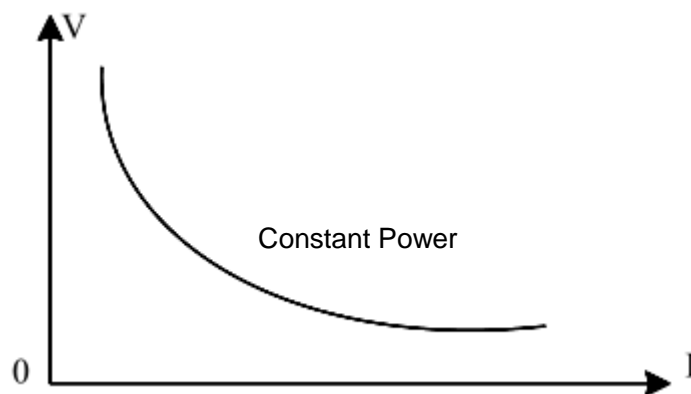

Figure 4-1-4 Relationship of Voltage and Current in CP Mode

#### Operation steps:

1. After starting up, first press the CH button to select the operating channel. The yellow wireframe area is the selected channel. And CH1 or CH2 will be displayed at the top of the screen (UTL8212 only).
2. Press the Mode button to enter the mode selection interface, select the CP mode with the pulse knob or direction buttons, and then press Enter to enter the test interface.
3. Adjust the power setting value (constant power value) with the knob.
4. Press the ON button to start the operation, and press the ON button again to stop it.

#### 4.1.5 Dynamic Test

In the dynamic mode, the users can set two fixed-value parameters. Through the set operation mode, the load is switched back and forth between the two values.

Table 4-1-5-1 Dynamic Mode CC Setting Interface

[Dynamic]		[Local]			
Operating mode	Continues		Repeat	01000	
Lower value	1.000	A	Lower duration	100.0	ms
Upper value	5.000	A	Upper duration	100.0	ms
Rise slope	0.100	A/us	Fall slope	0.100	A/us

#### Parameters of dynamic mode:

Dynamic mode	Description
Operating modes	Continues/Pulse/Reverse
Lower value	Set the lower parameter value
Lower duration	Set the lower on-loading time
Upper value	Set the upper parameter value
Upper duration	Set the upper on-loading time
Rise slope	Set the rise slope
Fall slope	Set the fall slope
Repeat	Set the frequency of repetition cycles for an operation

#### Operating modes:

1. Continues: The load will automatically and continuously switch between two set high/low values till the operation reaches the set repeating times, and then the test

ends.

2. Pulse: Lower parameters will be on-loaded at first, and then the load will switch to an upper value each time when it receives a trigger signal, and it will switch back to the lower value at the end of the set time. In pulse mode, lower timing is not necessary because the reverse action will be triggered only once when one trigger signal is received.
3. Reverse: Each trigger will lead to the switching between the high and low value, and upper/lower timing is not necessary at this time. Only after each trigger will it switch to another status.

The users can set the parameters according to their own needs. The following figure 4-1-5 shows the low and high current values set in dynamic CC mode. The load will continuously switch back and forth between these two values.

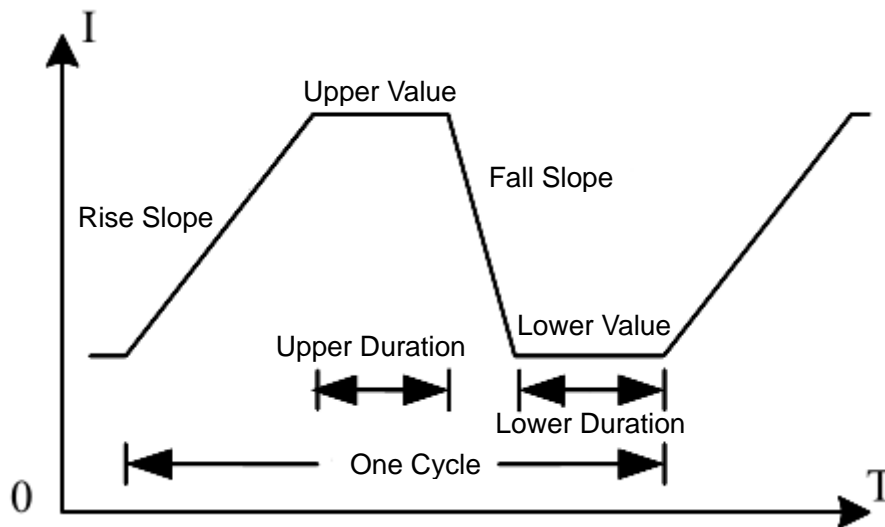

Figure 4-1-5 Dynamic Test Mode

#### Operation steps:

1. After starting up, first press the CH button to select the operating channel. The yellow wireframe area is the selected channel. And CH1 or CH2 will be displayed at the top of the screen (UTL8212 only).
2. Press the Mode button to enter the mode selection interface, select the dynamic mode with the pulse knob or direction buttons, and then press Enter to enter the dynamic mode setting interface.
3. Select the modified parameter with the pulse knob, press Enter to modify, and press Enter again to save the modification.
4. After setting the parameters, press the ON button to enter the dynamic test interface (channel 1: ON1, channel 2: ON2).
5. Press the ON button to start the operation, and press the ON button again to stop it.



**Note:** If the voltage position/current position is set to the low position, when the voltage/current value exceeds the range of the low position during load operation, the error information will be displayed. The users should return to the parameter setting interface, and refer to chapter 5.2 to adjust the voltage/current position.

### 4.1.6 List Test

The list test function can switch between different modes according to the set parameters. For power products and charger devices, through multi-parameter mixed test, the users can have a more comprehensive understanding of the operating characteristics of the tested product in actual applications.

#### Parameter setting in list mode

List mode	Parameters	Description
Group	1~60	Set the group number of the list test files for easy calling
Step	1~16	Set the step of the list test
Repeat	0~99999	Set the number of repetitions of the current list file
Mode	Continues/Trig/Con+Err/Trig+Err	Set the switching mode of each step and the stopping mode

#### Group :

The internal Flash of the electronic load can save 60 groups of list files. When setting the list parameters, please set a proper group number first. Err means that when there are abnormal conditions such as out of inspection range during operation, the load will automatically stop loading. First press Shift, and then press the Save button to finish saving.

#### Mode :

There are four options for setting the operating mode: Continues/Trig/Con+Err/Trig+Err.

Continues: The load will continue the next step after executing one step until the end of the operation.

Trig: The load will pause after executing one step, and wait for the trigger signal before continuing the next step.

Err: The test will automatically stop when over range or other errors occur during the load operation.

#### Mode parameter setting

		Description
Mode	CC/CV/CR/CP/Open/Short	Load operation mode
Value	Set constant value	Open/Short default value: 1
Time	300~999999ms	Set the load execution time for each step between 300~999999ms
Check	Off/Curr/Volt/Power	Select check item
Min	Minimum value of the check item	Set minimum value of the check item
Max	Maximum value of the check item	Set maximum value of the check item

After the test is completed, the users can press Shift +Result to view the test results. If the test result is within the set upper and lower limits, Pass will be displayed; otherwise Fail will be displayed instead. The users can also check whether each item is passed.

When using the check function, the value range of the item cannot be checked in the single constant value mode. For example: In CC mode, only the voltage value and power value can be checked, not the upper and lower limits of the current. After setting the parameters, press ON1/ON2 to transfer the list files to the corresponding channel.

**Operation steps:**

1. After starting up, first press the CH button to select the operating channel. The yellow wireframe area is the selected channel. And CH1 or CH2 will be displayed at the top of the screen (UTL8212 only).
2. Press the Mode button to enter the mode selection interface, select the list mode with the pulse knob or direction buttons, and then press Enter to enter the list mode setting interface.
3. Select the modified parameter with the pulse knob, press Enter to modify, and press Enter again to save the modification.
  - When setting list parameters (group, step, repeat, mode), first press the Enter button to enter the modifiable status, then use the knob to select the proper mode or adjust to the appropriate value, and finally press the Enter button to complete the setting.
  - When setting mode parameters (mode, check), position the cursor on the parameter that needs to be set, press Enter to view different parameter options, stop pressing on the selected option, and then press the direction buttons or rotate the pulse knob to enter the next parameter setting.
  - When setting the mode parameters (value, time, min, max), position the cursor on the parameter that needs to be set and press Enter. At this time, the setting xxxx at the bottom of the screen will change to a specific value which can be adjusted by rotating the pulse knob, and then press Enter to complete the setting.

**Note:** During the setting process, if the set value exceeds the limit, an ERROR pop-up window will appear. Press the Enter button and the window will disappear. The users need to adjust the value to the range with the pulse knob to complete the setting; otherwise the pop-up window will continue to appear.
4. After setting the parameters, press the ON button to enter the list test interface (channel 1: ON1, channel 2: ON2).
5. Press the ON button to start the operation, and press the ON button again to stop it.

#### 4.1.7 Battery Test

Battery mode is used to detect the battery capacity. Battery capacity is an important indicator which reflects battery life and reliability. The voltage will decrease as the discharge time increases when testing the battery capacity, so the stop voltage should be set. When the stop voltage is reached, the test ends.

**Battery mode parameters:**

Parameters	Description
Mode	Battery discharge mode: CC/CR/CP
Load value	Set loading value

Stop voltage	Set the lower limit voltage of stopping discharge
--------------	---

In the battery mode, select any needed discharge mode, and set the load parameters and stop voltage of this mode. When the battery is discharged to the stop voltage, the electronic load will automatically stop loading.

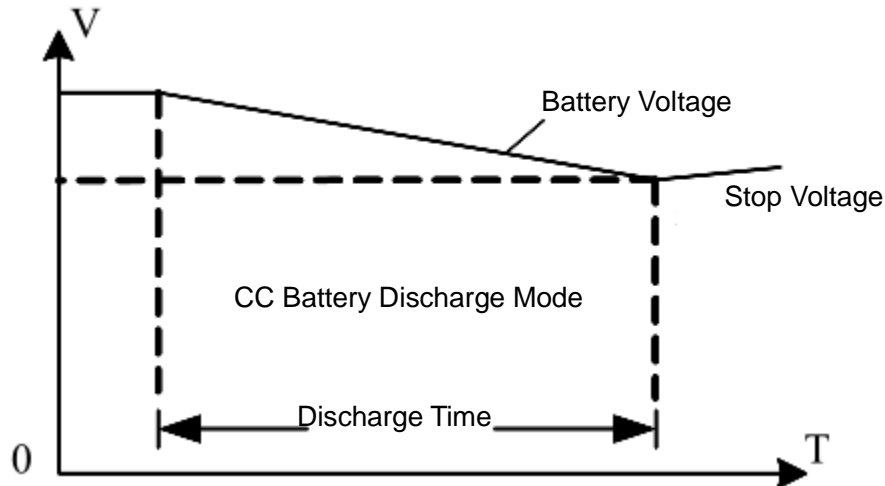

Figure 4-1-7 Battery Mode

#### Description of battery mode:

In the actual test process, the users can check the battery voltage, discharge current and discharged capacity at any time.

#### Operation steps:

1. After starting up, first press the CH button to select the operating channel. The yellow wireframe area is the selected channel. And CH1 or CH2 will be displayed at the top of the screen (UTL8212 only).
2. Press the Mode button to enter the mode selection interface, select the battery mode with the pulse knob or direction buttons, and then press Enter to enter the battery mode setting interface.
3. Select the modified parameter with the pulse knob, press Enter to modify, and press Enter again to save the modification.
4. After setting the parameters, press the ON button to enter the battery test interface (channel 1: ON1, channel 2: ON2).
5. Press the ON button to start the operation, and press the ON button again to stop it.

## 4.2 Short Circuit Test

In CC/CV/CP/CR mode, when the electronic load is with voltage (at least 0.5V), press Shift, then press the → button (Shift+→=short) to turn on the short circuit test mode. A short circuit symbol [Short] will be displayed on the screen.

#### Operation steps:

1. After starting up, first press the CH button to select the operating channel. The yellow wireframe area is the selected channel. And CH1 or CH2 will be displayed at the top

- of the screen (UTL8212 only).
2. Press Shift +Mode to enter the main menu interface.
  3. Use the knob to select the parameter setting, and then press Enter to enter the parameter setting interface.
  4. Use the knob to set the short circuit time, and press Enter to complete the setting.
  5. Press the Mode button to enter the mode selection interface, select the CC/CV/CP/CR mode, press Shift+→(short) to enter the short circuit mode, and the symbol [Short] will appear. Set the corresponding current value with the knob and press the ON1/ON2 button to complete the short circuit test.

## 4.3 Parameter Input and Operating Control

### 4.3.1 Parameter Input

There are two ways to input parameters: rotate the knob or press the direction buttons. When the set parameter is out of range, it will not be saved by pressing Enter. Please reset the correct parameter.

### 4.3.2 Operating Control

After the electronic load is powered on, it is in an unloaded status. Control the input switch of the load by pressing the ON1/ON2 button on the front panel. When the ON button indicator light is on, it means it is in the loaded status, and when the ON button indicator light is off, it means it is in the unloaded status.

## 4.4 Alarm Prompts

1. Overvoltage protection: load input voltage is higher than the set value of overvoltage protection.
2. Overcurrent protection: load current is higher than the set value of overcurrent protection.
3. Power protection: the load power is higher than the set value of over power protection.
4. Polarity error: The positive and negative poles of the load input terminal are reversed.
5. Undervoltage protection: When the load is operating, it is detected that the input voltage is lower than the unloading voltage set value.
6. Data overrange: The data entered is out of range (the upper limit of parameters such as voltage/current/power/time).
7. Position error: If the voltage position/current position is set to the low position, when the voltage/current value exceeds the range of the low position during load operation, the error information will be displayed. The users should return to the parameter

setting interface, and refer to chapter 5.2 to adjust the voltage/current position.

8. Logic error: The input data does not conform to logic. For example: (1) In CC mode, the product of voltage and current exceeds the load maximum power. (2) If the upper limit value entered in the list mode is lower than the lower limit value, a warning window will be displayed. Please reset the appropriate value.

## 4.5 Local/Remote

The electronic load has two operating modes: local and remote. The load can switch between two operating modes by pressing the Local button. The initial operation mode is local by default.

Local: Use the buttons on the electronic load to operate. The upper computer cannot remotely control the load, and only the current operating data can be read.

Remote: The electronic load is connected to the PC through communication cables, and commands are sent on the PC to perform operations on the load through the upper computer software. When the electronic load is in remote mode, except for the Local/Remote button, other buttons on the panel will not work. When the users do not need the remote function, they can switch to local mode by pressing the Local/Remote button.

The status bar at the top of the screen will display Local/Remote, indicating the current control status of the load. The users can judge the control status according to the screen display.

## 5. System Configuration Page (Menu)

- System Configuration
- Parameter Setting
- File
- Instrument Info

The main menu setting is divided into four parts: system configuration, parameter setting, file, and instrument info. The parameter setting only affects the selected channel (for UTL8212, first press the CH button to select the setting channel), and other settings are effective to the whole instrument.

First press Shift, then press Mode to enter the system <Menu> setting page, as shown in Figure 5.

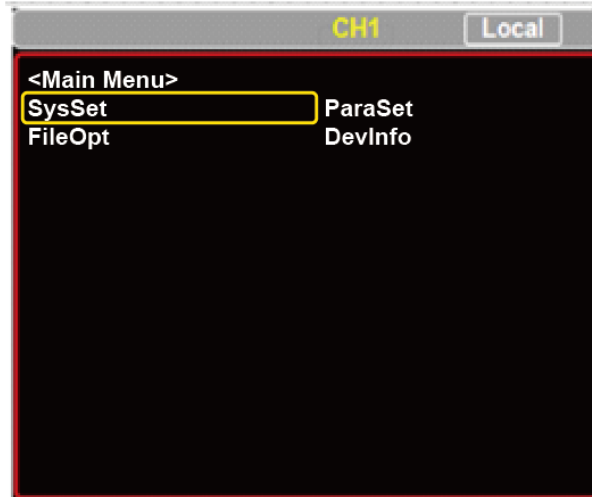

Figure 5 <Menu> Setting Page

### 5.1 System Configuration

Put the cursor on the field [System Configuration] and press [Enter] to enter the <System Configuration> page.

System parameters	Setting contents	Description
Language	[CHN]/English	Set system language
Knob active	On/Off	If it is ON, the parameter will change immediately after rotating the knob.
Warn sound	On/Off	Whether to enable warn sound
Key sound	On/Off	Whether to enable key sound
Initial mode	Default/Last	Default: Boot into the CC mode interface Last: Boot into the last test mode
Restore factory setting		Choose to restore factory settings: The instrument will delete the current setting parameters and restore to the status of factory settings
Baud rate	9600/19200/38400/57600/115200	Set the baud rate of RS232 communication interface
Address	001~032	Set the current communication address

#### Example [Language]



Figure 5-1-1 Current Setting Status (Yellow, Locked)





Figure 5-1-2 Settable Status (White, Unlocked)

**Setting steps:**

1. Use the knob or direction buttons to position the cursor on the field [Language], as shown in Figure 5-1-1. The text is yellow, showing the current setting status is locked and cannot be modified.
2. Press Enter to unlock the current settings. At this time, the text is white, as shown in Figure 5-1-2, indicating that it is in the settable status.
3. The users can view setting options with the pulse knob, and the text of each option is still white.
4. Press Enter to confirm the selected option. The option text is yellow and the setting is complete.
5. Press the ESC button to return to the previous level, and press the ESC button again to enter the main operating interface.

The other setting operations are the same.

## 5.2 Parameter Setting

The parameter setting is used to set the operating parameters and protection parameters of the system. The detailed setting range is related to the model.

Parameter setting	Setting range	Description
Run time	0~99999s	Set the time of each load. No matter in which mode, the load will stop automatically when it operates to the corresponding operating time.
Short time	0.1~99999ms	Set the time for a single short circuit test
V limit	0~150V	Set the voltage value of over-voltage protection
I limit	0~20A (40A)	Set the current value of over-current protection
P limit	0~200W (400W)	Set the power value of over-power protection
V on	0~150V	Set the load voltage at the beginning of each operation
V off	0~150V	Set the low voltage to automatically end loading
V trigger	0~150V	In list mode, the load will operate automatically when it detects a voltage value higher than the self-start voltage at the measuring terminal.
OVP	ON/OFF	When the input terminal voltage is higher than the protection voltage, directly short-circuit the input terminal.

Voltage position	Low/High	Used to manually select the voltage range position. Default: low.
Current position	Low/High	Used to manually select the current range position. Default: high.

## 5.3 File

File operations are mainly for recalling and deleting list test files. The storage method of list files is internal Flash, and the users can view the stored files.

Select a list file and press Shift +ESC (Delete) to delete it.

Select a list file and press the ON button to enter it.

## 5.4 Instrument Info

The Instrument info page can view the basic information of the electronic load, including the model, version number and serial number.

## 6. Communication

- Communication Interfaces
- Communication Settings

### 6.1 Communication Interfaces

The UTL8200 series electronic load is equipped with standard RS232 communication interface. The users can use the corresponding communication cable for remote operation. There is a DB9 female interface at the end of the electronic load, which can be connected to the computer COM port by using a standard RS232 cable.

When the users want to purchase a USB communication cable, please choose a USB to serial RS232 cable.

**Note:** In actual use, the electronic load only uses three pins (2, 3 and 5) to communicate with the device.

#### Definition of RS232 pins:

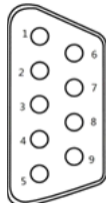
Pin NO.	Symbol	Description	
1	DCD	Data carrier detect	
2	TXD	Transmit data	
3	RXD	Receive data	
4	DTR	Data terminal ready	
5	GND	Ground	

6	DSR	Data set ready	
7	RTS	Request to send	
8	CTS	Clear to send	
9	RI	Ring indicator	

## 6.2 Communication Settings

The communication settings are mainly used to set the communication mode between the electronic load and the upper computer. The electronic load communicates with the upper computer through RS232. The users can purchase the needed connecting cable to achieve remote control with the electronic load. Before connecting to the upper computer, please make sure to purchase the designated connection lead and set the correct communication parameters.

### Settings steps:

1. First press Shift, and then press Mode to enter the system <Menu> setting page.
2. Press [System Configuration] to enter the <System Configuration> page.
3. Select [Address] and [Baud Rate] in the <System Configuration> page, and set the communication parameters to be consistent with the upper computer.

**UNI-T®****UNI-TREND TECHNOLOGY (CHINA) CO., LTD.**

No.6, Gong Ye Bei 1st Road,  
Songshan Lake National High-Tech Industrial  
Development Zone, Dongguan City,  
Guangdong Province, China

Made in China